



Music Virtual Learning

# 7th Grade Orchestra

April 30, 2020



## 7th Grade Orchestra

Lesson: April 30, 2020

**Objective/Learning Target:** Students will be able to apply key signature knowledge to scales and pieces.

# Warm-Up



Can I be a freelance

See the following slide to find out

musician?

Interview Questions Here

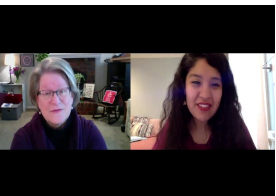

# Lesson



# Let's Review How to Identify Key Signatures

If you missed last week's lesson on key signatures, please review the 4/23 lesson.





Review how to identify sharp key signatures:

1. Find the last sharp on the right.
2. Go up one  $\frac{1}{2}$  step and that is the name of the key!  
In this example, F# is the last sharp. Move up a  $\frac{1}{2}$  step, and we are in the key of G Major.



Violin

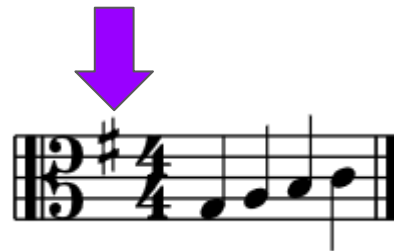

Viola

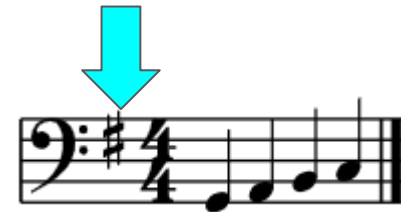

Cello/Bass



Review how to identify flat key signatures:

1. Find the second to last flat on the right. That is the name of the key!

The only key you have to remember is that one flat is **F major**. Shown below:

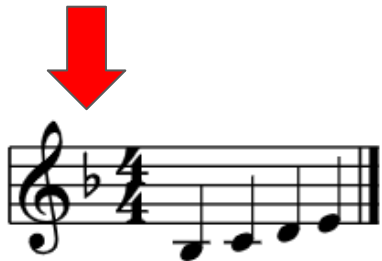

Violin

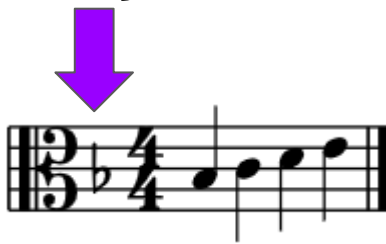

Viola

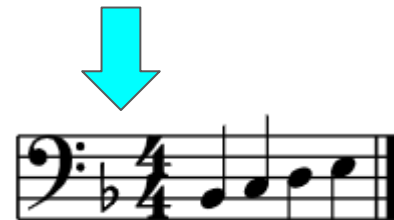

Cello/Bass

# Putting It All Together

**KEY SIGNATURES, SCALES,**

**AND FINGER PATTERNS...OH MY!**

The key signature, scale, and finger patterns in a piece of music all work together.

First, let's review a song we learned last week!

Violas, Cellos, and Basses, keep scrolling down a little until you see your piece.

# Violin: Be Our Guest

What key is it?  
Remember to  
check the key  
change at the  
end.

[Click HERE for Music](#)



1st Key



2nd Key

Remember the W-W-H-W-W-W-H pattern for scales

Here are the scales for these keys (half steps and some tricky finger patterns marked):

Try to play these slowly before practicing the piece

1. G Major

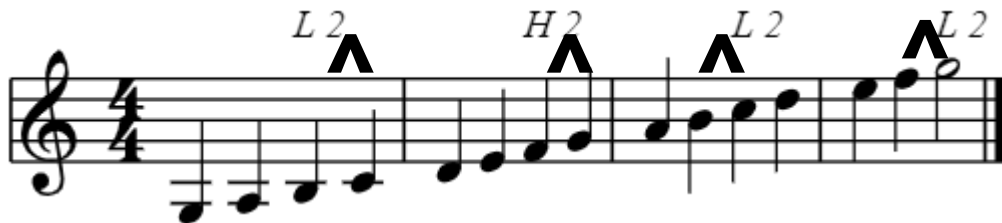

2. B flat Major

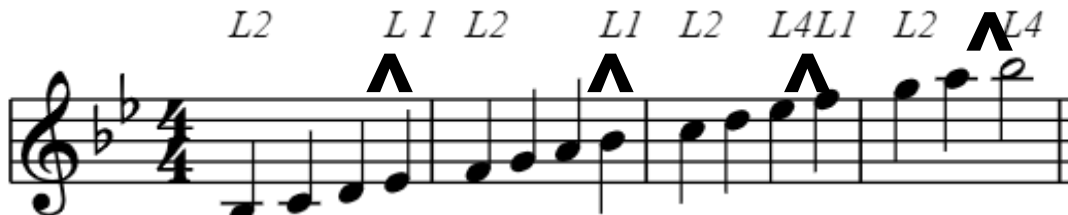

1. Visualize the finger patterns for each key on your instrument.
2. Mark tricky finger patterns in your music.

### G Major

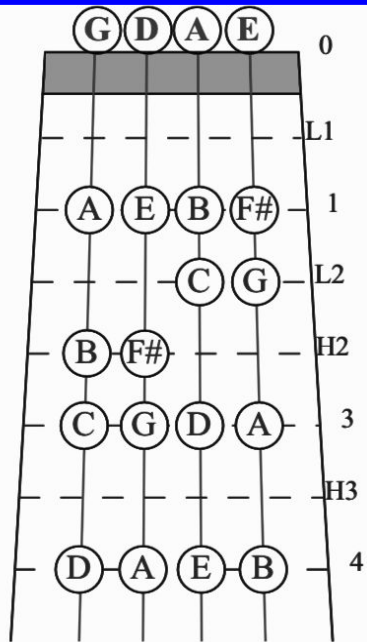
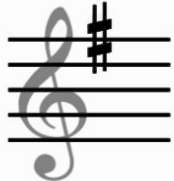

### Bb Major

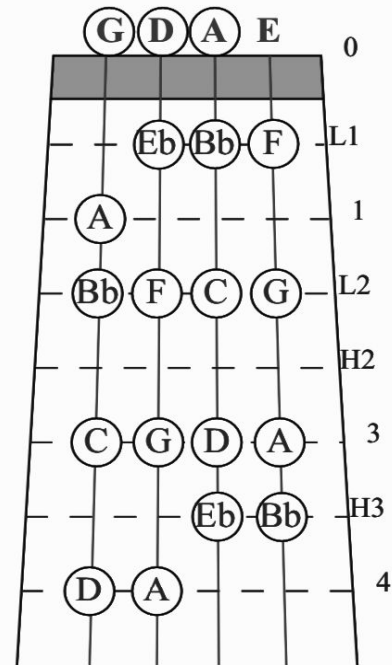

# Viola: A Whole New World

What key is it?  
Remember to  
check the key  
change at the  
end.

[Click HERE For Music](#)



1st Key



2nd Key



Remember the W-W-H-W-W-W-H pattern for scales

Here are the scales for these keys (half steps and some tricky finger patterns marked):

Try to play these slowly before practicing the piece

1. G Major

Musical notation for G Major scale in bass clef, 4/4 time. The scale is G2-A2-B2-C3-D3-E3-F#3-G3. Fingerings are indicated by numbers 1-4 above the notes. Accents are placed above the B2, D3, and F#3 notes. A 'L2' label is above the E3 note, and '-1' is above the F#3 note.

2. B flat Major

Musical notation for B flat Major scale in bass clef, 4/4 time. The scale is Bb2-C3-D3-E3-F3-G3-A3-Bb3. Fingerings are indicated by numbers 1-2 above the notes. Accents are placed above the D3 and G3 notes. 'L2' labels are above the C3 and F3 notes, and 'L1' labels are above the D3 and G3 notes.

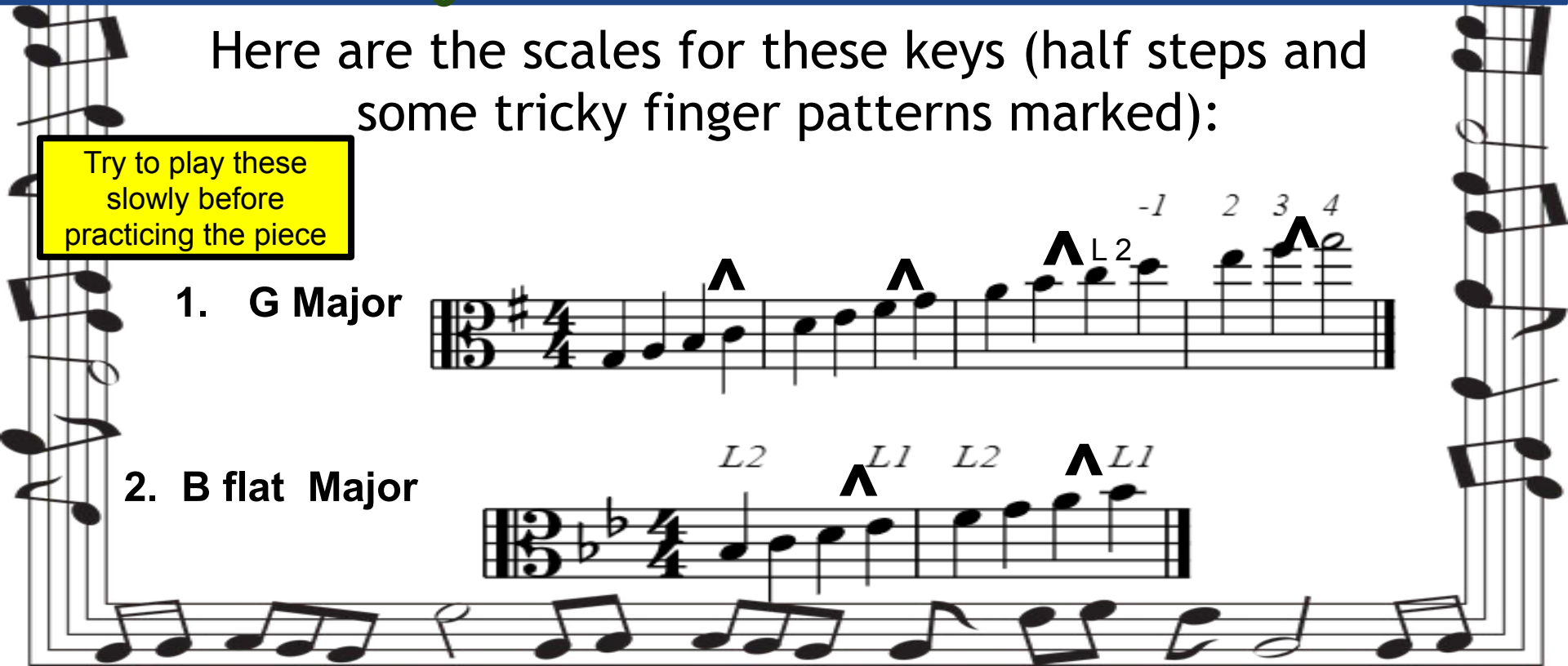

1. Visualize the finger patterns for each key on your instrument.
2. Mark tricky finger patterns in your music.

### G Major

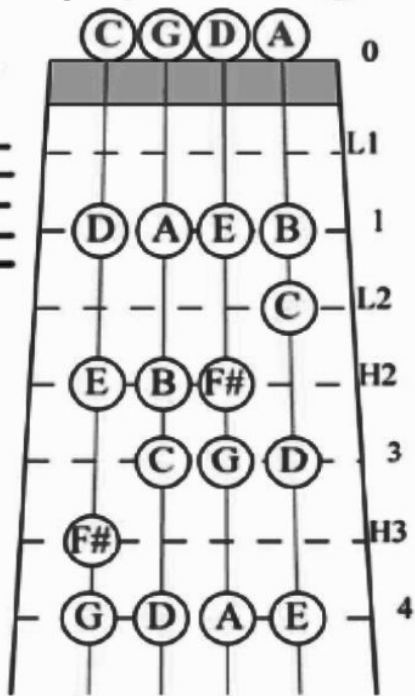

### Bb Major

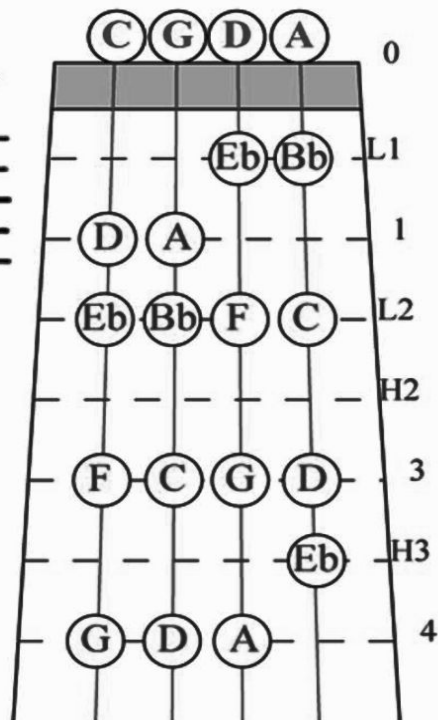

# *Cello: Be Our Guest*

[Click HERE for Music](#)

What key is it?  
Remember to  
check the key  
change at the  
end.

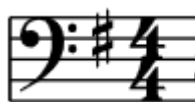

**1st Key**

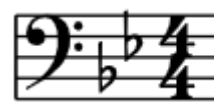

**2nd Key**

Remember the W-W-H-W-W-W-H pattern for scales

Here are the scales for these keys (half steps and some tricky finger patterns marked):

Try to play these slowly before practicing the piece

1. G Major



2. B flat Major



1. Visualize the finger patterns for each key on your instrument.
2. Mark tricky finger patterns in your music.



**G Major**

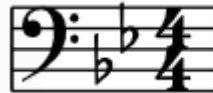
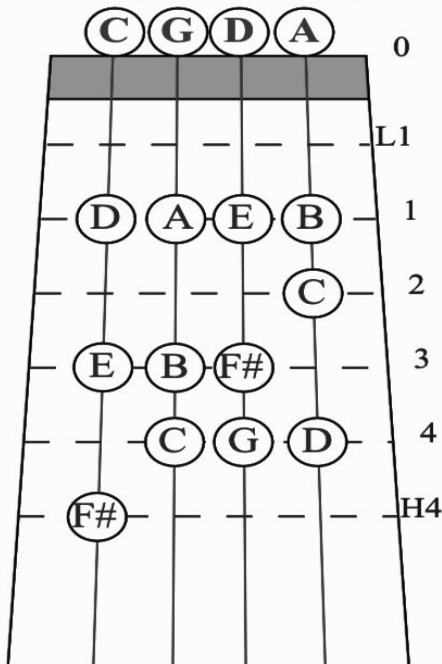

**Bb Major**

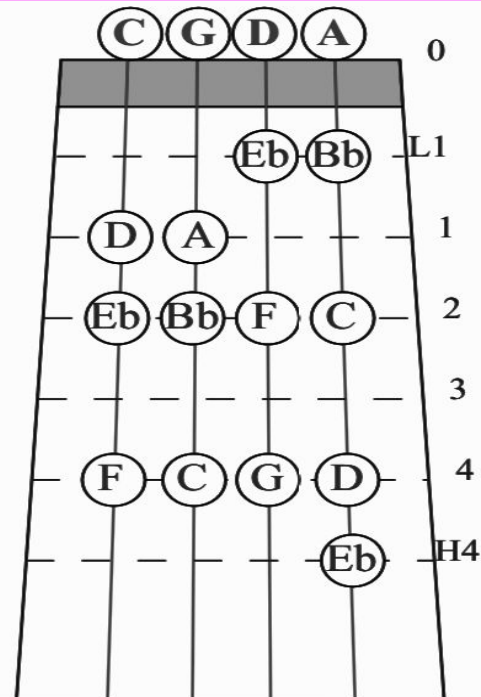

# Bass: Be Our Guest

[Click HERE for Music](#)

What key is it?  
Remember to  
check the key  
change at the  
end.



1st Key

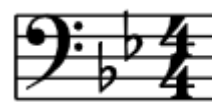

2nd Key

**Remember the W-W-H-W-W-W-H pattern for scales**

Here are the scales for these keys (half steps and some tricky finger patterns marked):

Try to play these slowly before practicing the piece

1. G Major

2. B flat Major

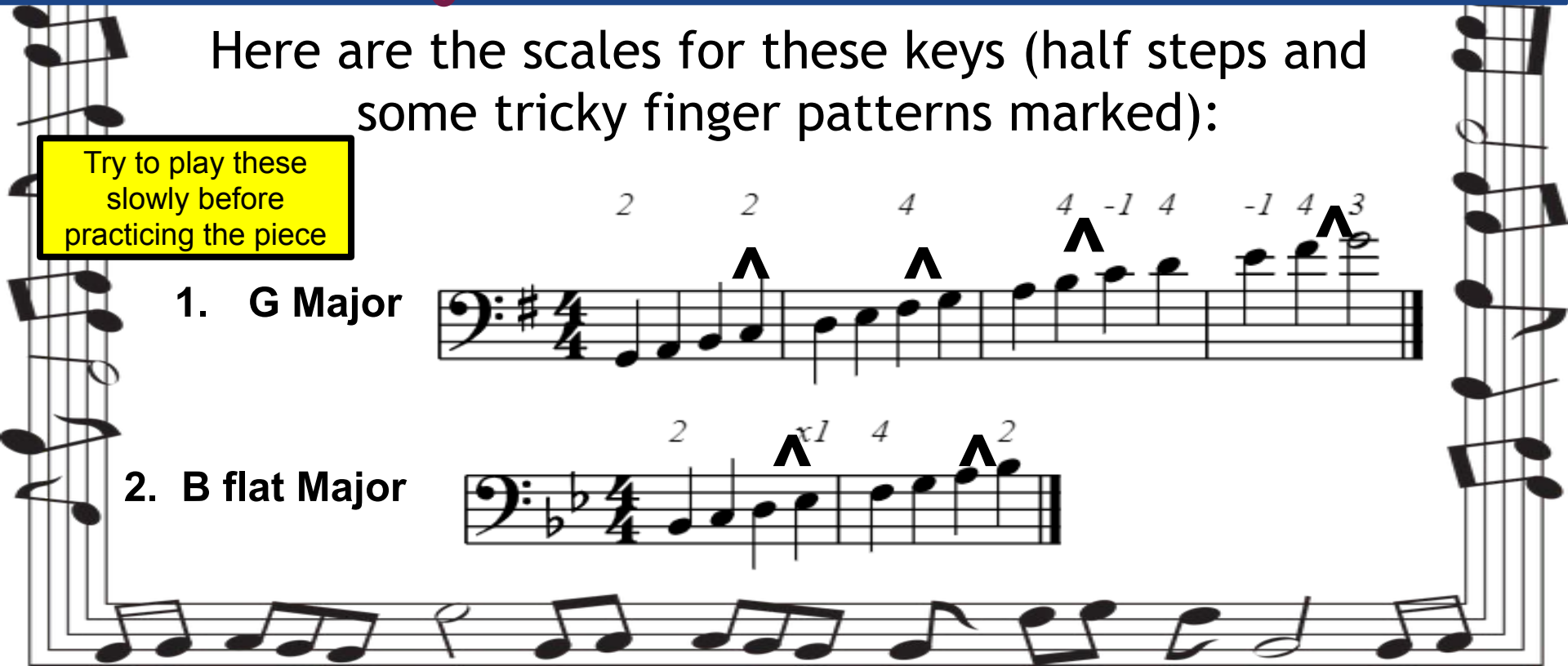



1. Visualize the finger patterns for each key on your instrument.
2. Mark tricky finger patterns in your music.



**G Major**

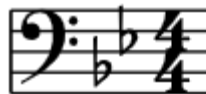
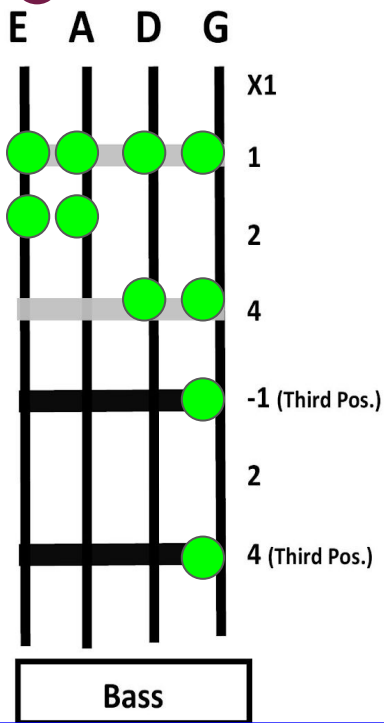

**Bb Major**

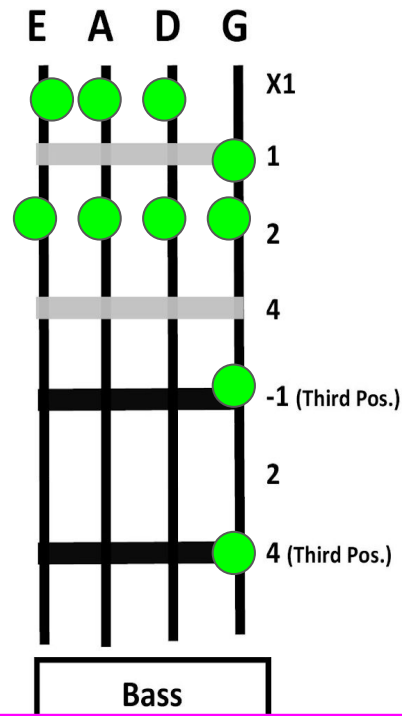

# Review



Try drawing the finger patterns for the G major scale on these fingerboard charts. Click on your instrument below:



**Violin:**  
**Click**  
**Here**



**Viola:**  
**Click**  
**Here**



**Cello:**  
**Click**  
**Here**



**Bass:**  
**Click**  
**Here**

# Self-Assessment

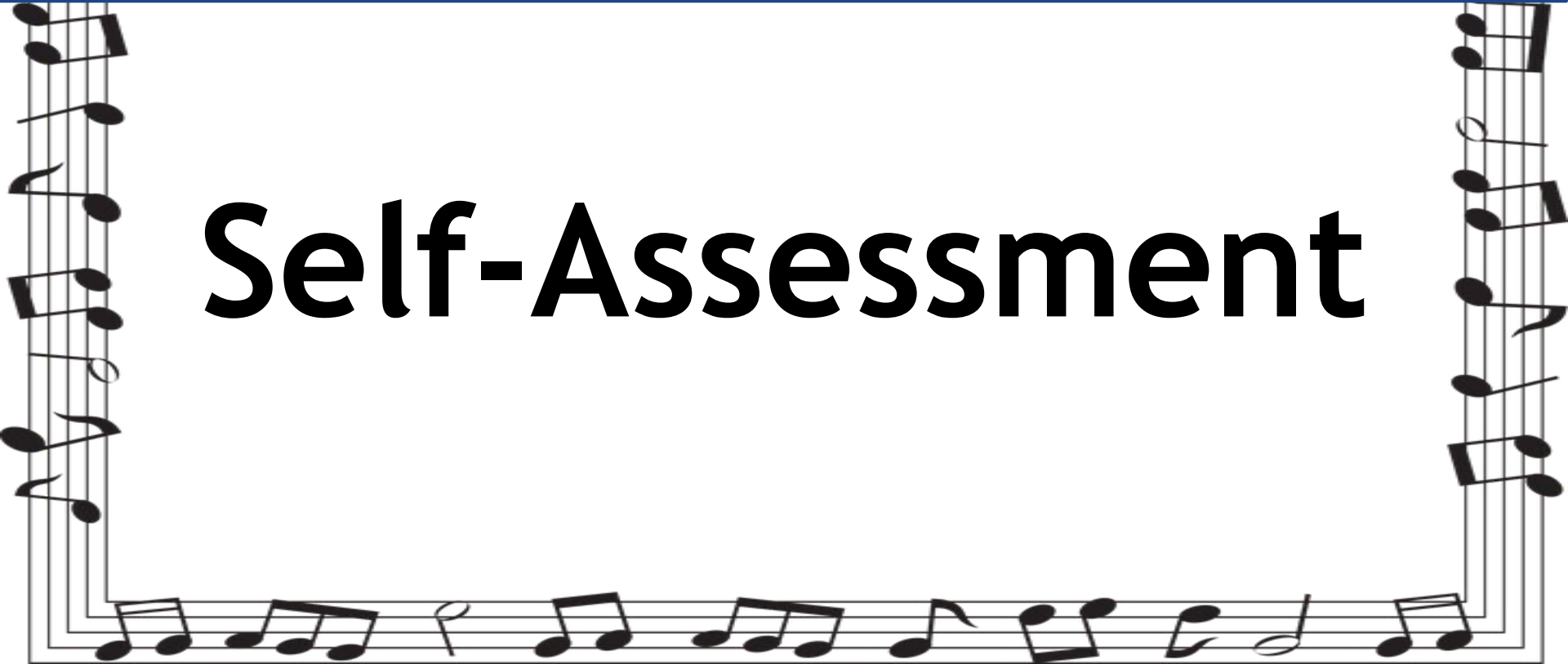



**Check your work!**

**Go back to the slides  
above to check your  
G major fingerboard  
chart**

# Additional Materials

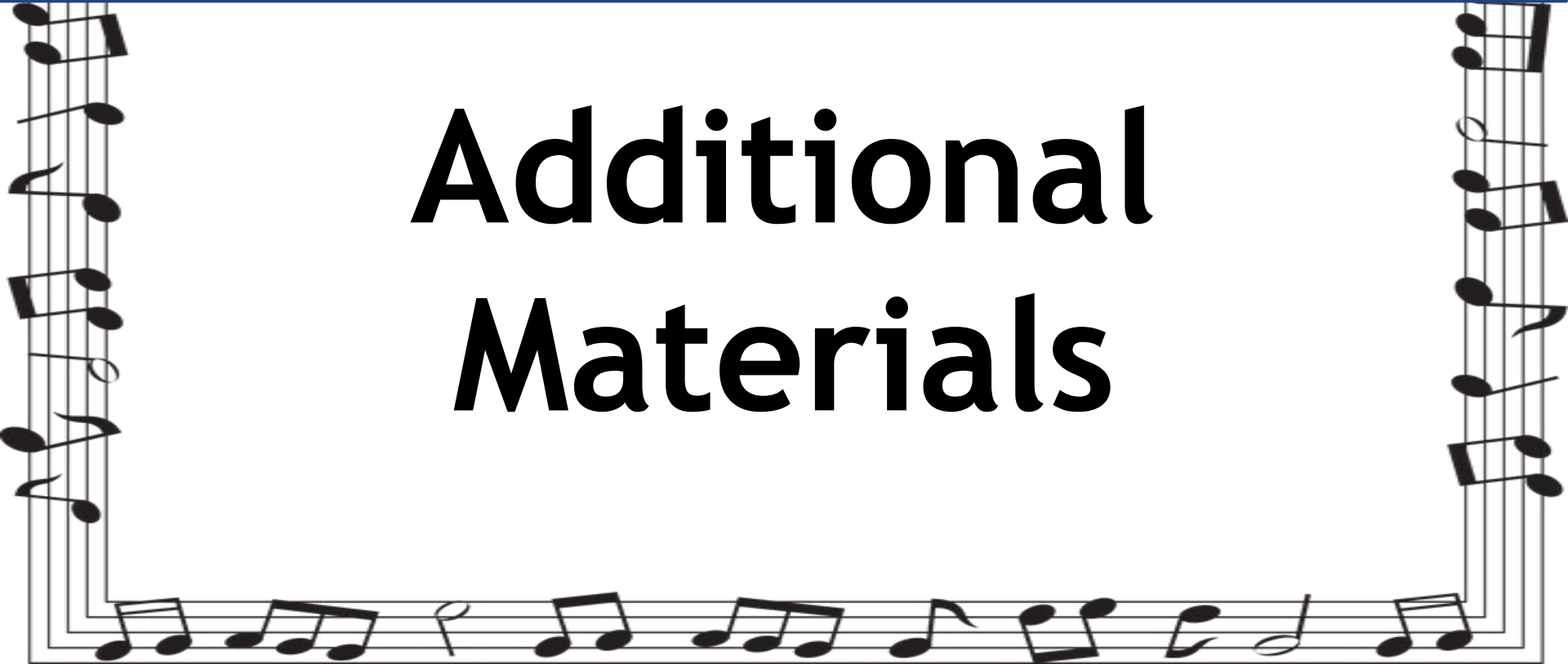

Key  
Signatures  
explained a  
little  
differently

## Why Do We Have Key Signatures?

